

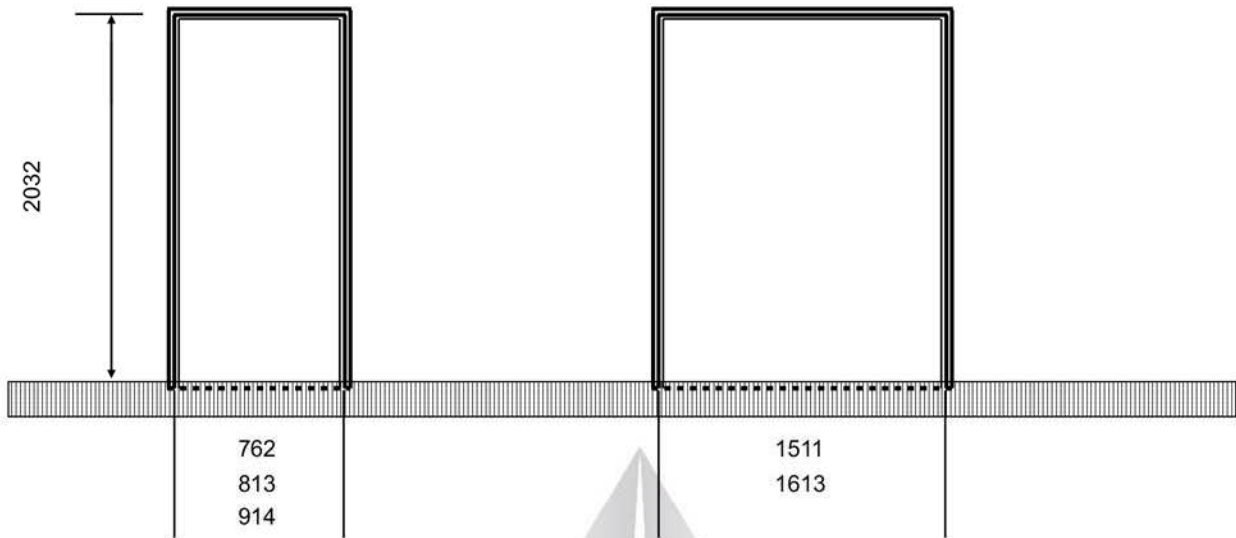

STEEL CATALOGUE

STEEL DOORFRAMES



TO DETERMINE DOOR "HAND", STAND ON SIDE OF HINGES. WHEN HINGES FITTED ON LEFT SIDE = LEFT HAND DOORFRAME AND VICE VERSA.



SIZES IN MM

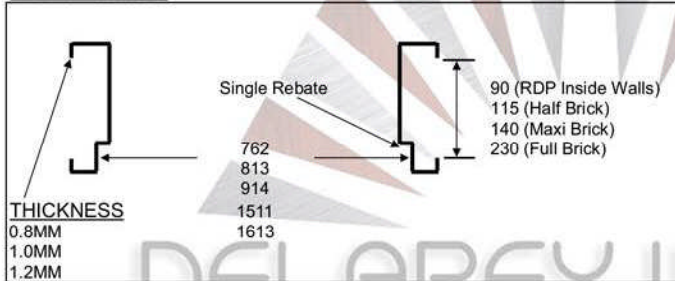

DOOR FRAMES - SIZE DESCRIPTION

Width x Height x Brick size x Thickness x "Hand"
Example:
813X2032X115X1.0MM LH

Note:
Double rebate doors have rebate inlets at both sides of frame.

Indicate whether frames is for screeded or non-screeded floor finishes.

COMBINATION DOORS

OPEN OUT COMBI DOOR

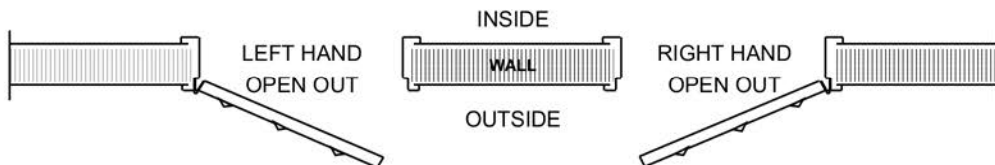

OPEN IN COMBI DOOR

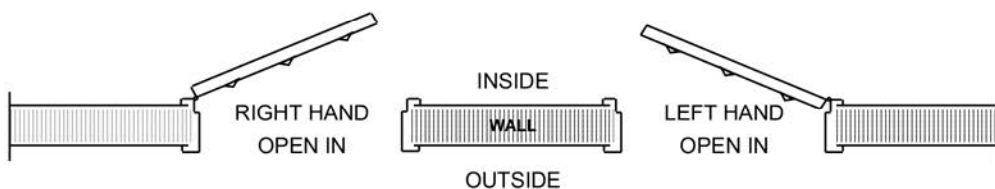

FRENCH DOOR

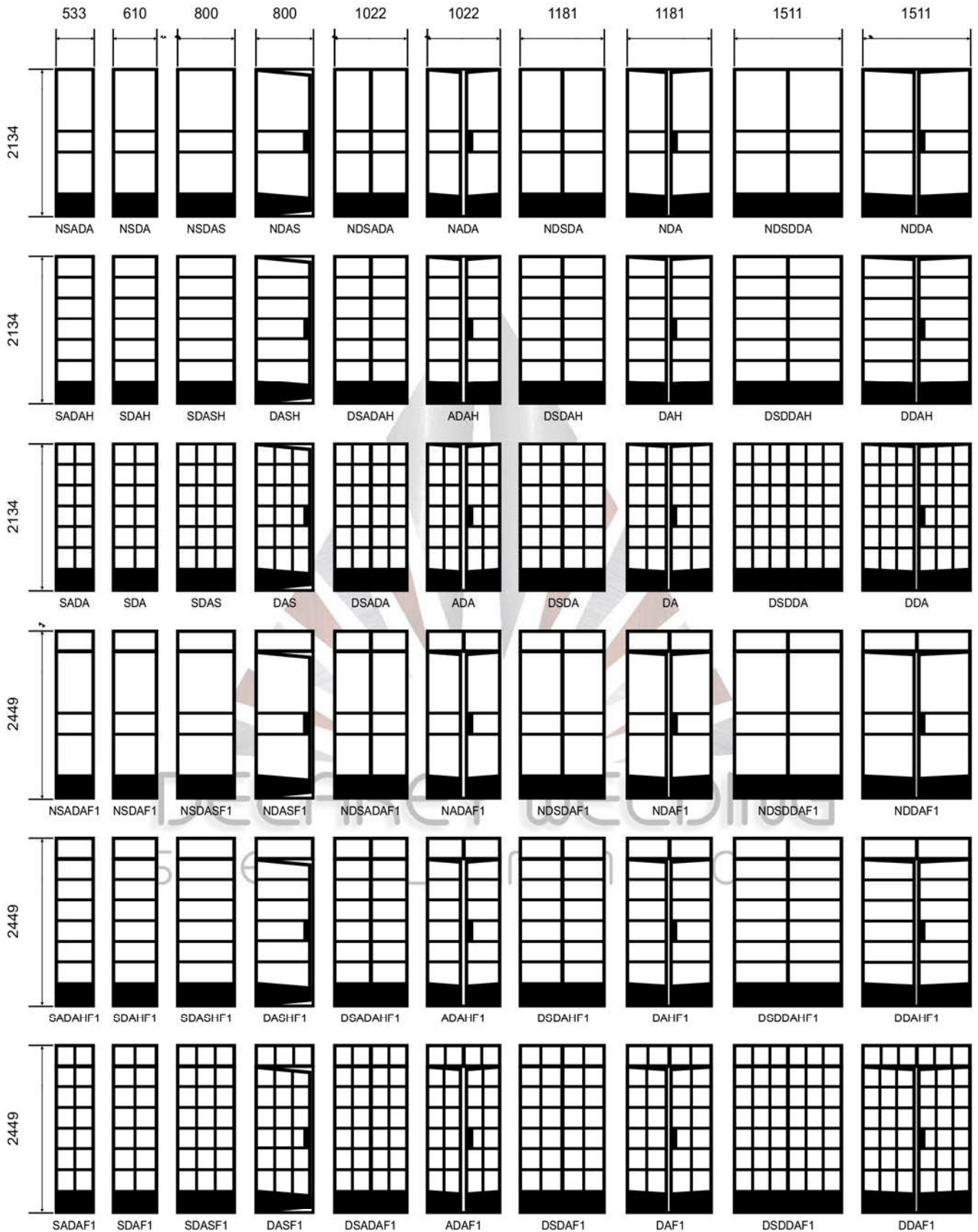

SEMI CIRCULAR FIXED FAN LIGHTS

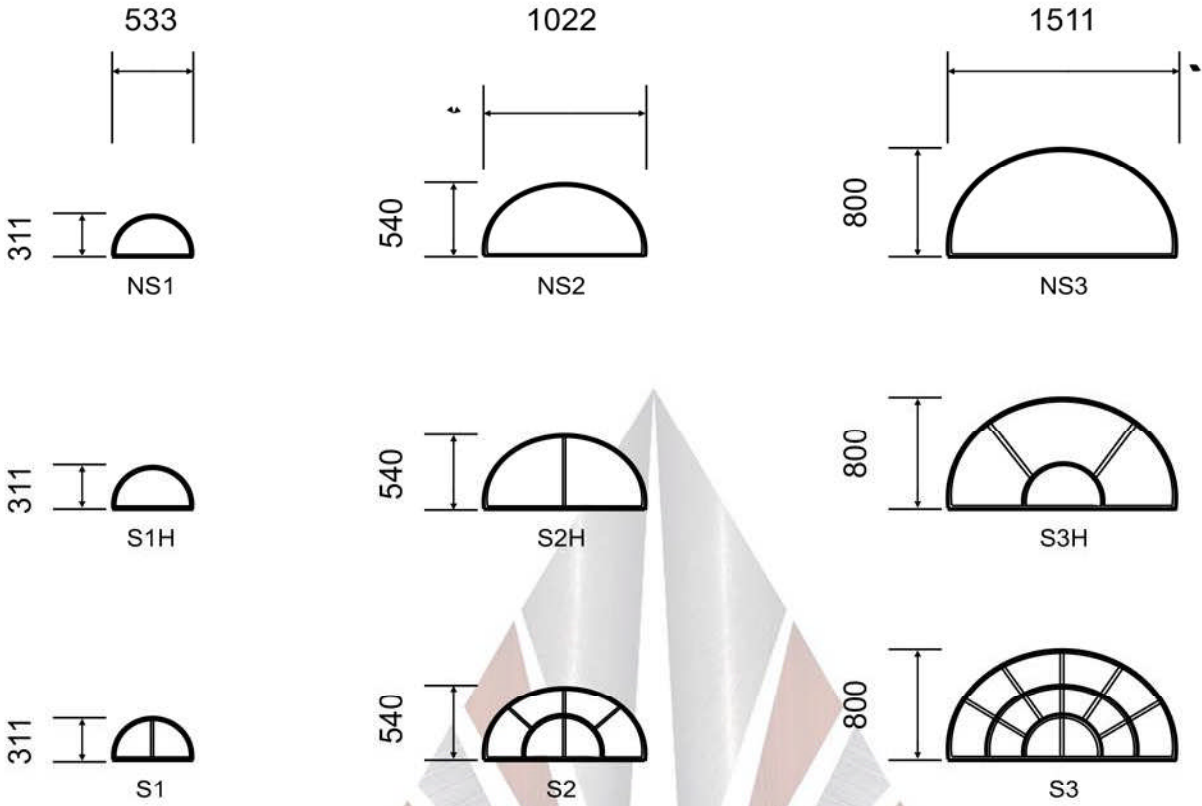

CIRCULAR FIXED FAN LIGHTS & OPENERS

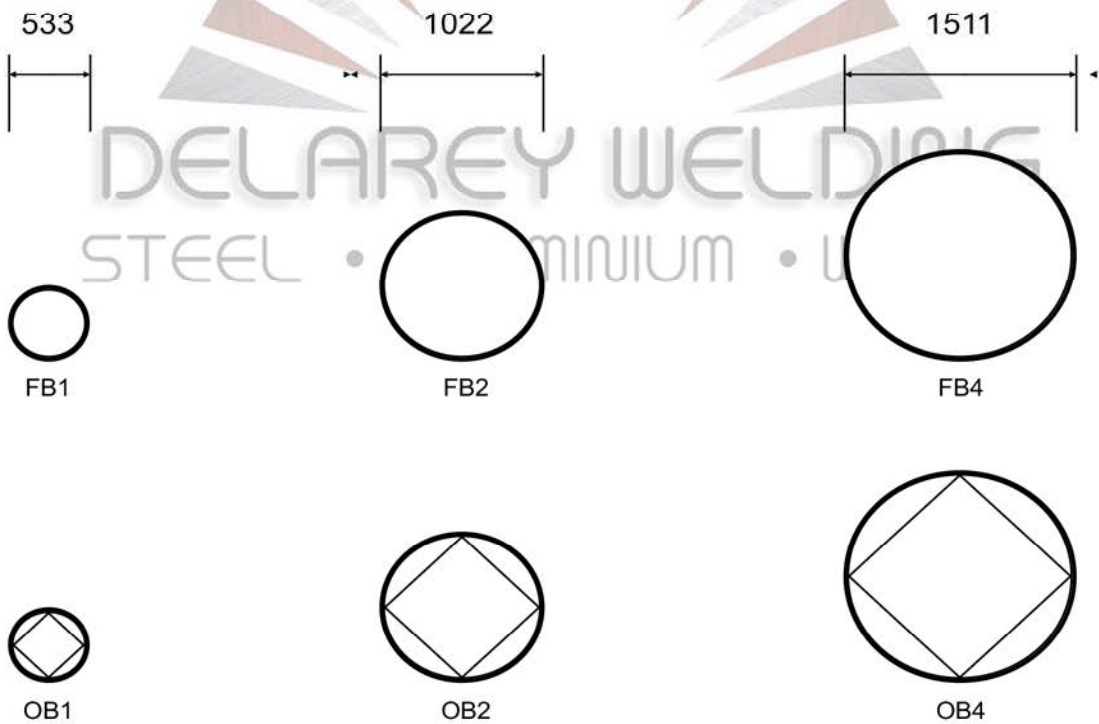

BURGLAR BARS

FLAT BAR - 20X5mm

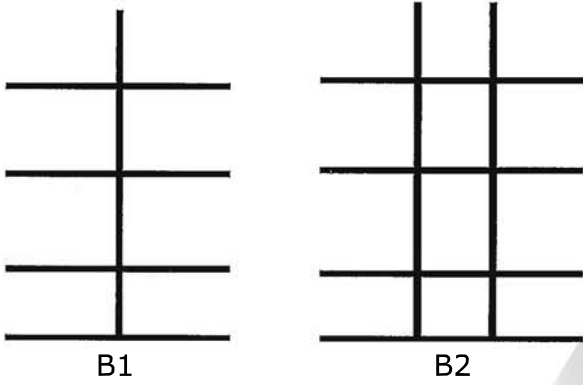

DIMENSIONS OF MATERIAL

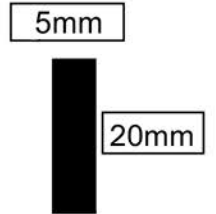

ROUND BAR - 10mm

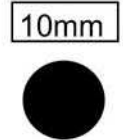
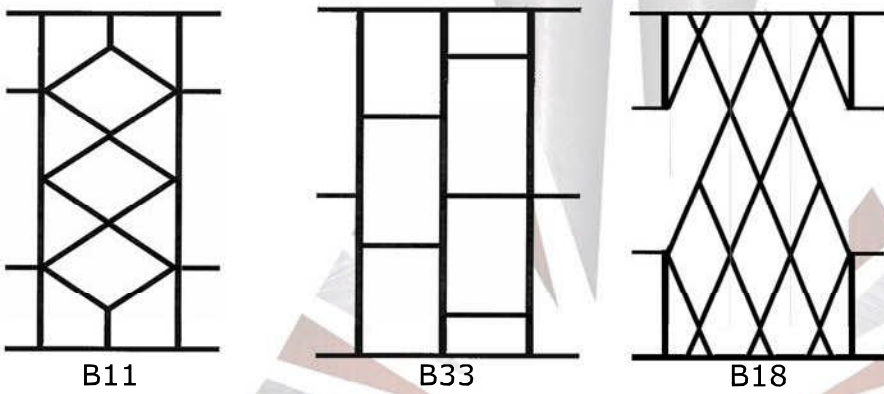

SQUARE BAR - 10mm



DELAKEY WELDING

EEL • ALUMINIUM • WOOD

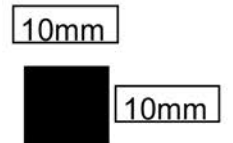

150mm Centres

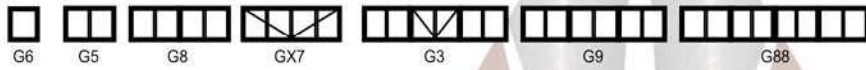
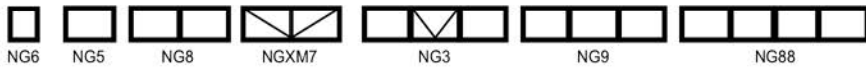
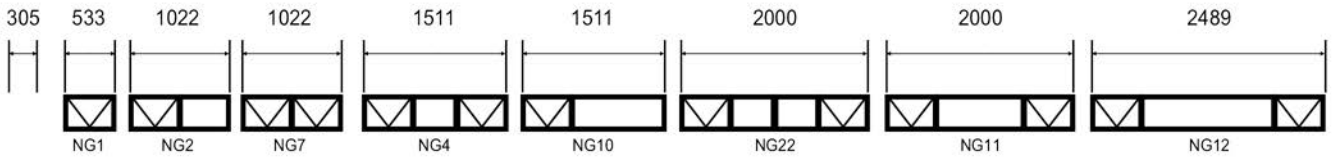

DELAREY WELDING
STEEL • ALUMINIUM • WOOD

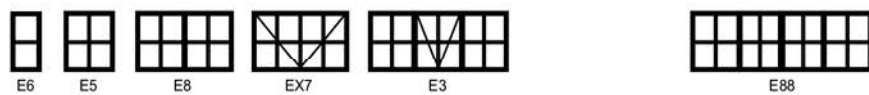
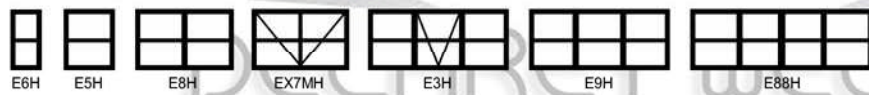
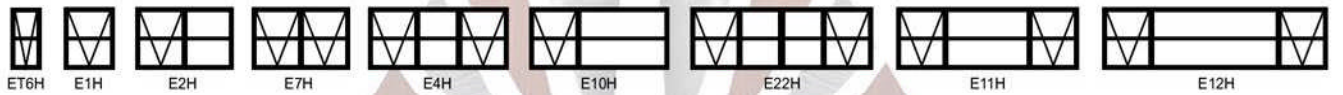
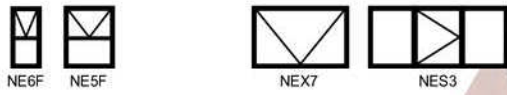
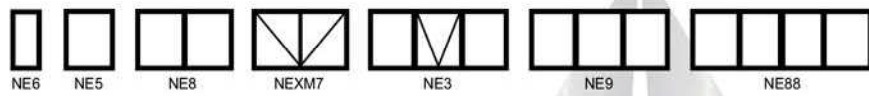
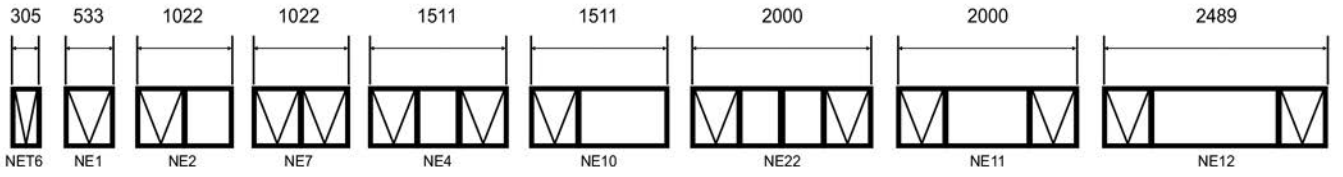

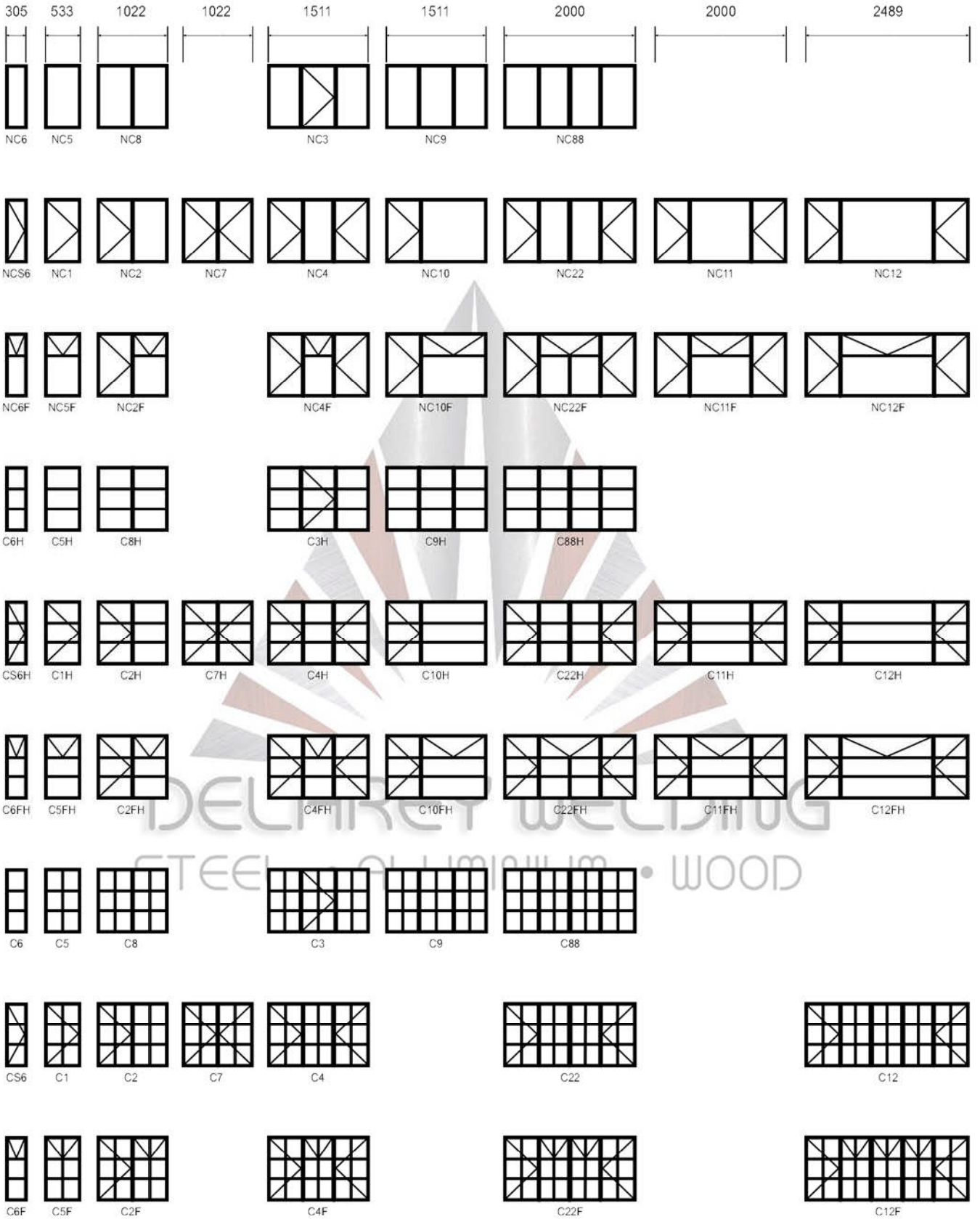

D TYPE

HEIGHT

1.245M

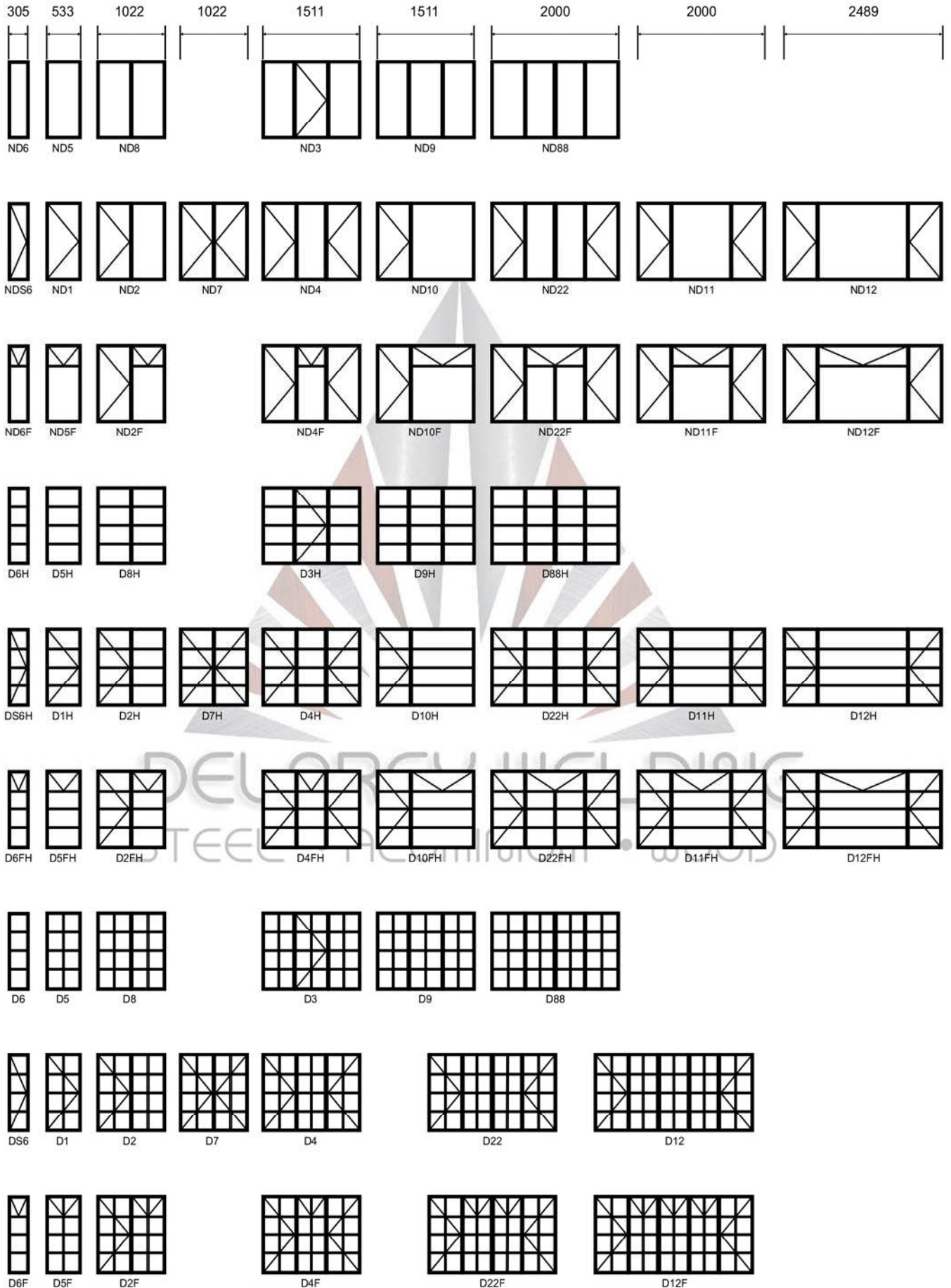

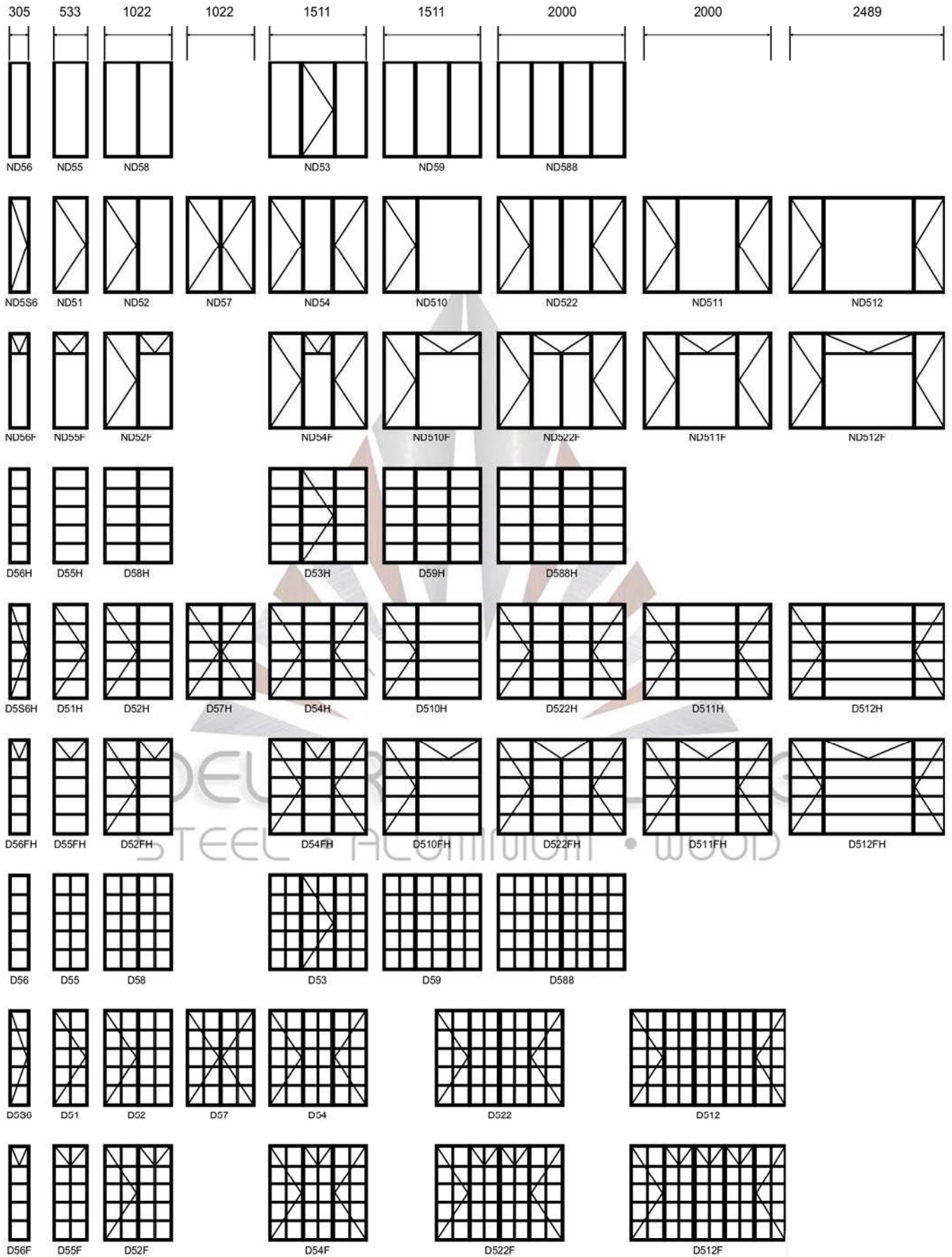

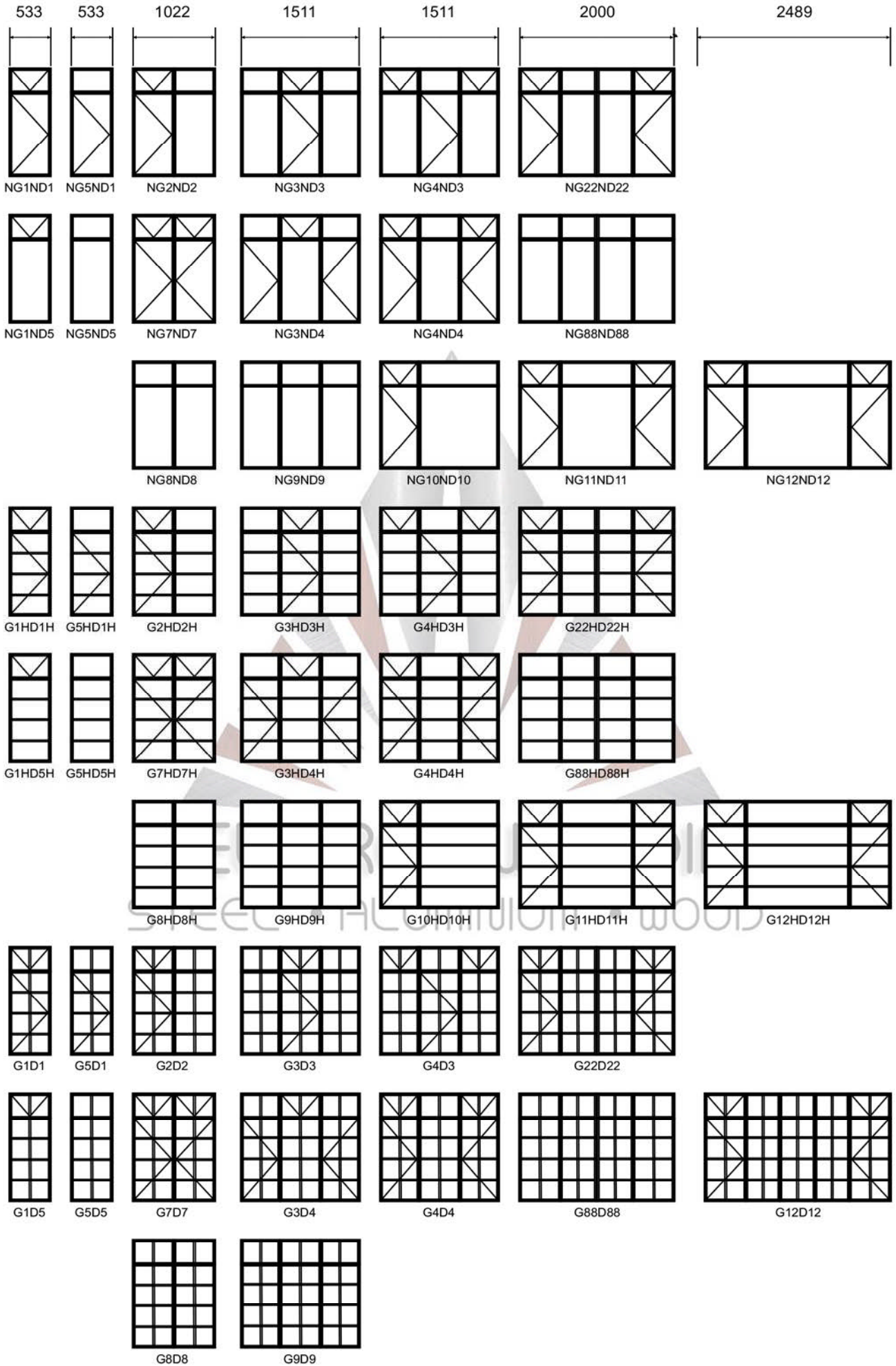

G/D50 TYPE

HEIGHT

1.854M

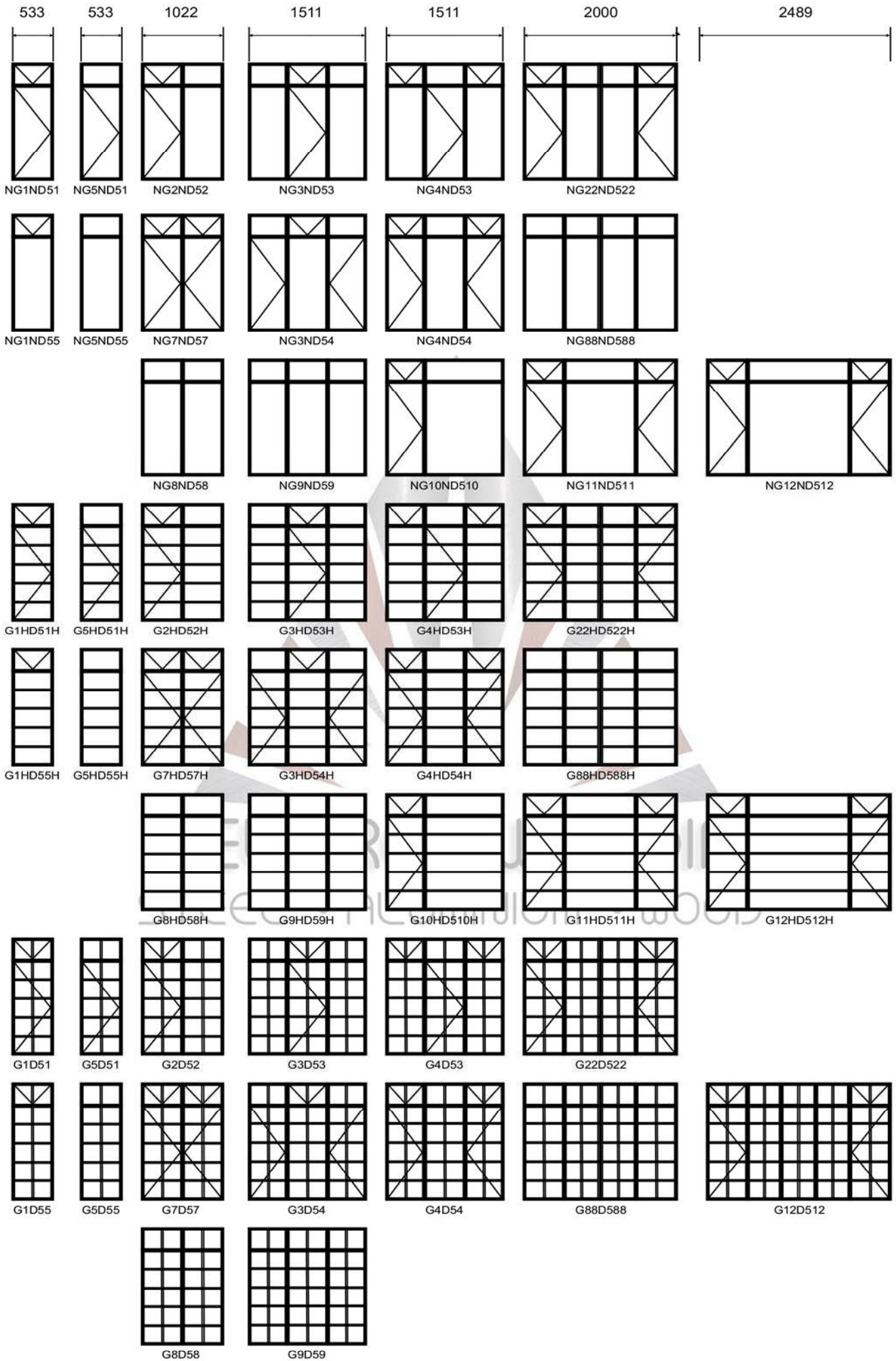

TD TYPE



STEEL • ALUMINIUM • WOOD

TD TYPE

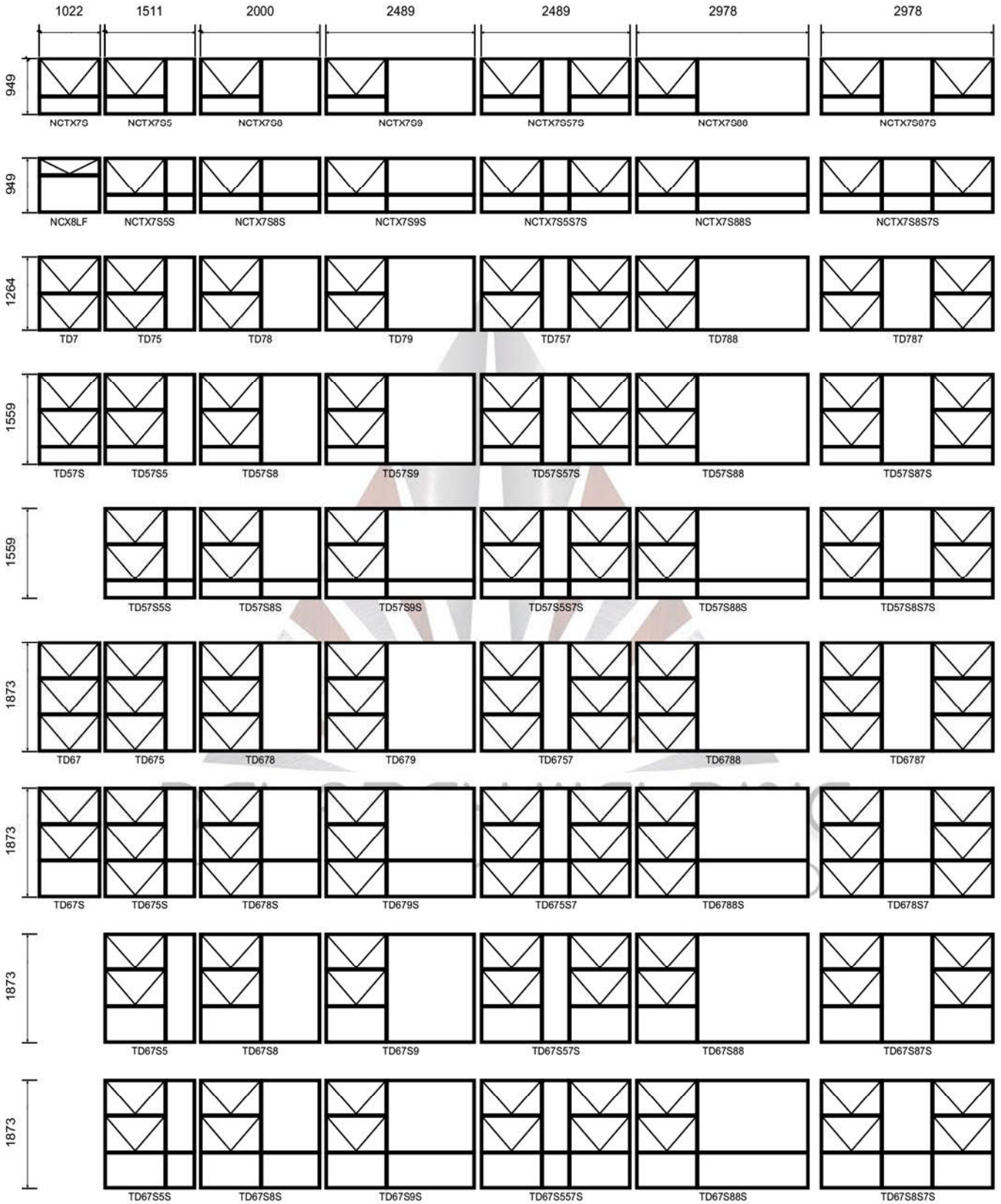

SS TYPE

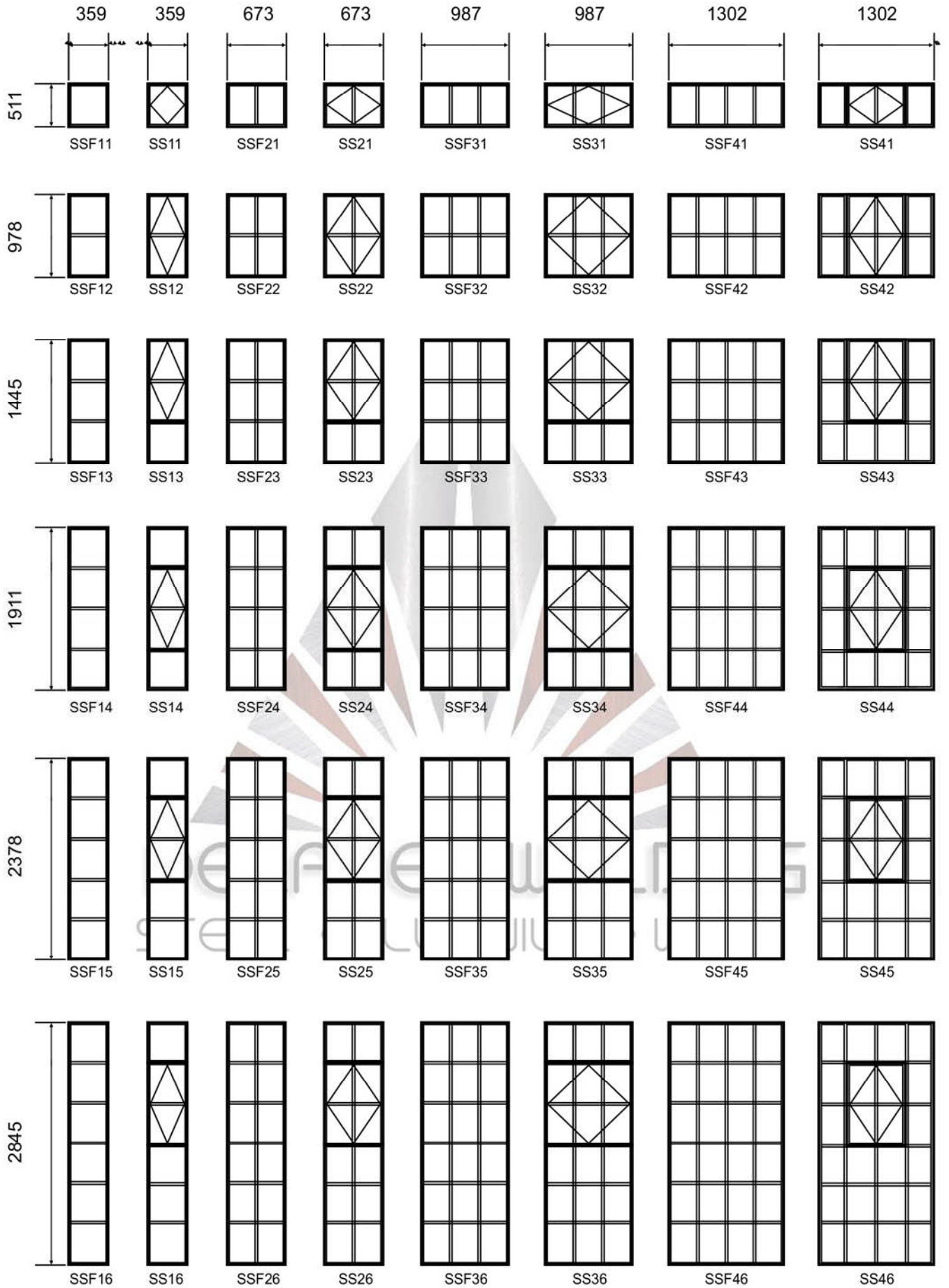

SS TYPE

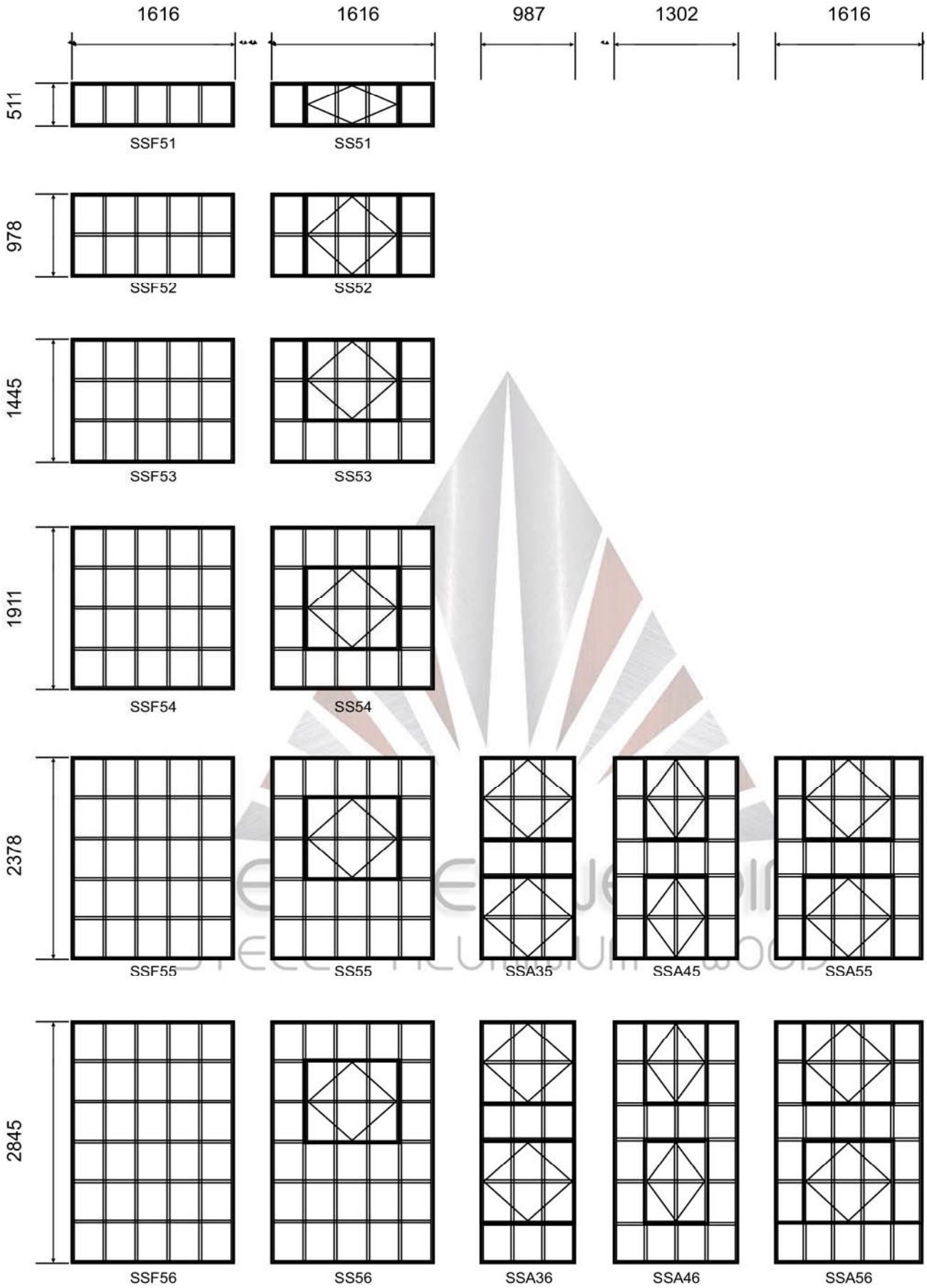

TRANSFORMER DOORS

All doors open outward

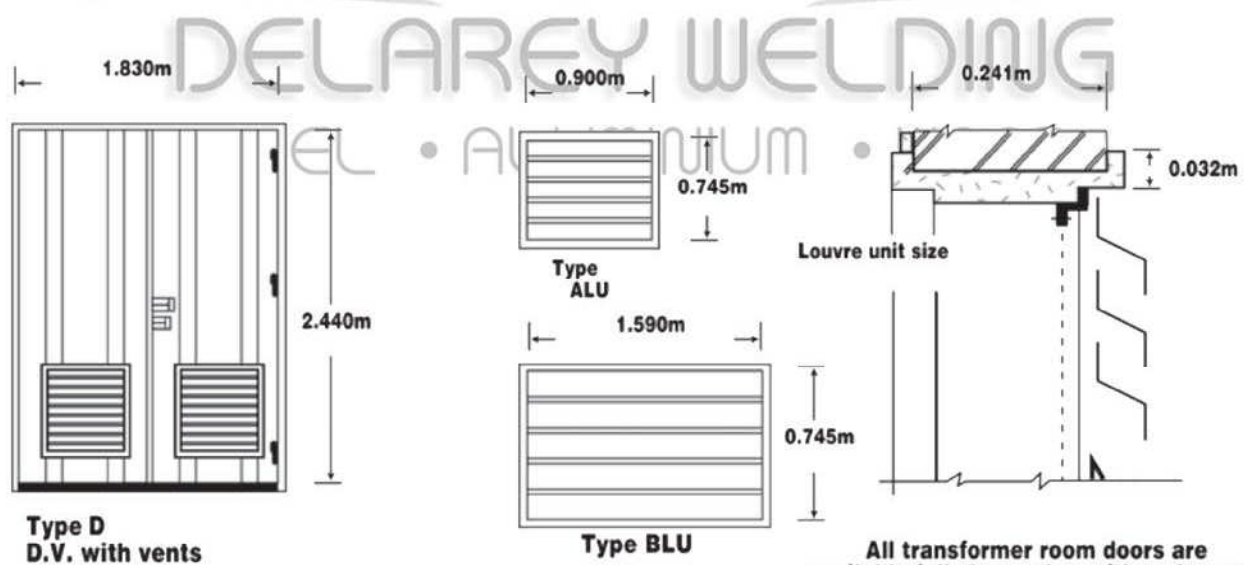
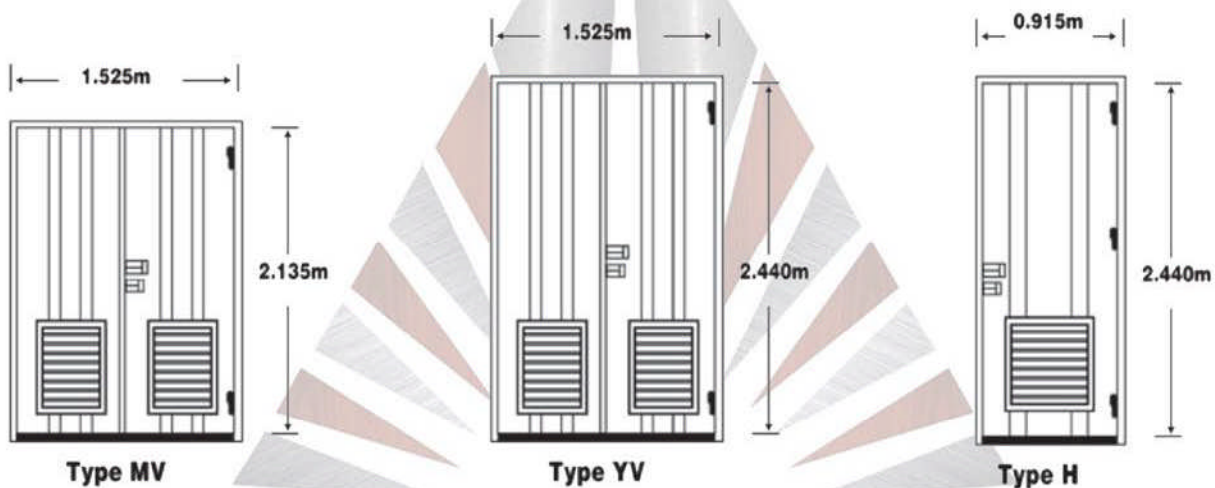
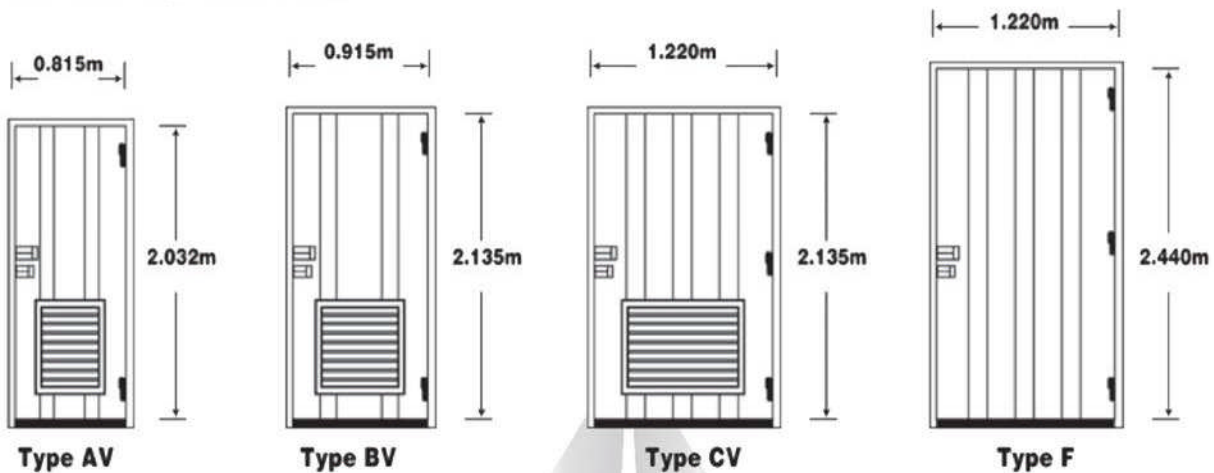

All transformer room doors are available fully louvred or with no louvres.